

TRANSPORTATION SYMPOSIUM

2019

Basics of Vessel Collision

Stephen Fowler, PE and Matthew Kosar, PE

Intro / Purpose of Vessel Collision Design

- Vessel collision (by barge or ship) with bridges poses a threat to public safety, port operations, traffic patterns, etc.
- 1960 – 2002: 31 major bridge collapses worldwide
 - Over 340 fatalities
 - Over one-half of those collapses have occurred in the United States

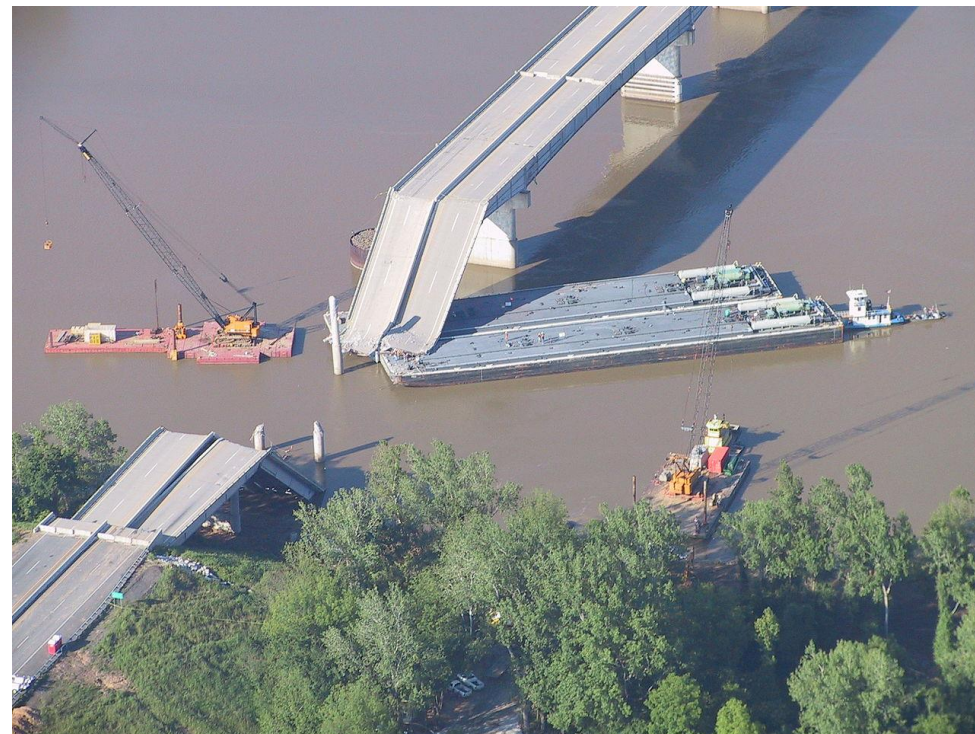

I-40 Bridge Over Arkansas River (2002)

But perhaps the most notable one to us all....

Sunshine Skyway Bridge Collapse (1980)

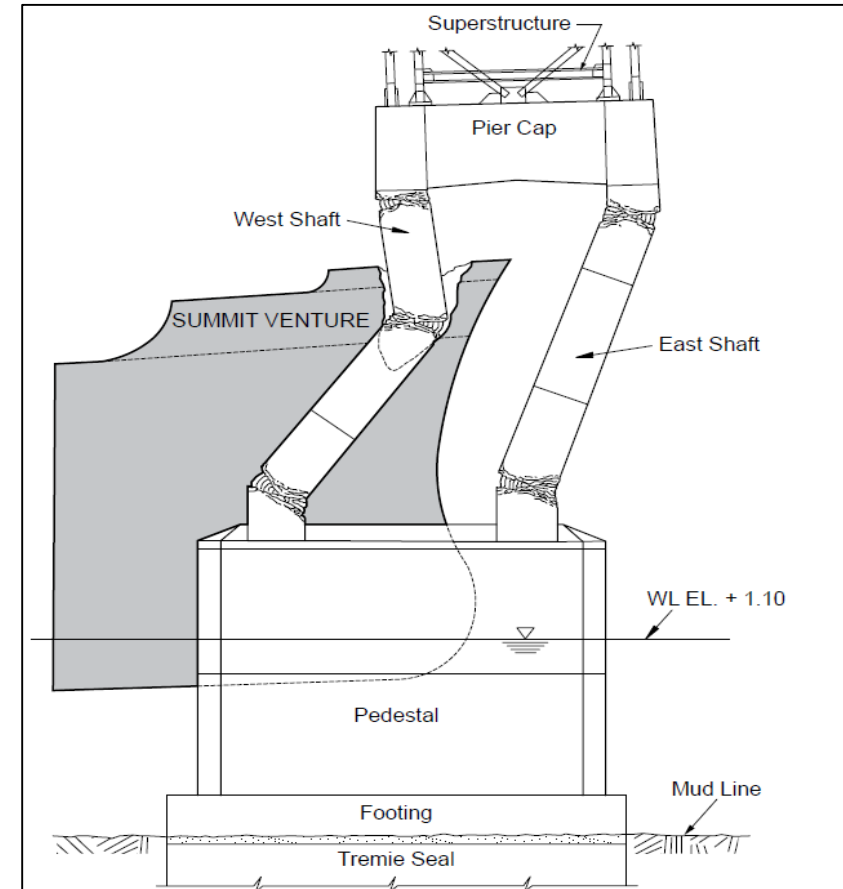
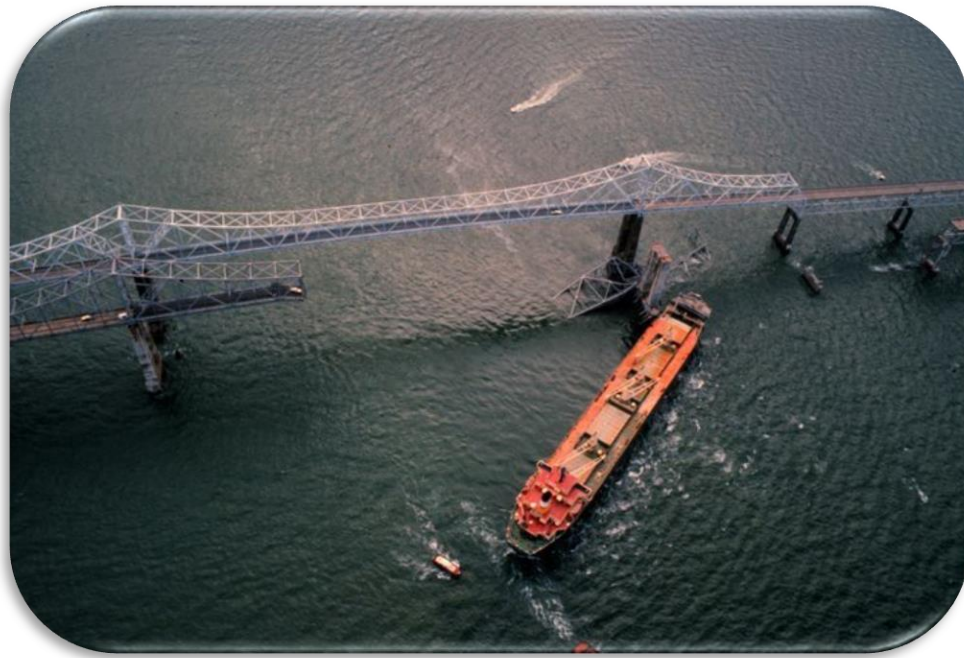

Figure C3.15.1-1—Collapse of Pier 2S of the Sunshine Skyway Bridge Subsequent to Impact by the Bow Overhang of the M/V Summit Venture

Reference: AASHTO Guide Specification and Commentary for Vessel Collision Design of Highway Bridges (Guide Spec)

Intro / Purpose of Vessel Collision Design

- As a result of the Sunshine Skyway Bridge collapse...
 - 1988: Pooled-fund research project sponsored by 11 states and FHWA for design code on evaluating vessel collision
 - 1991: AASHTO adopts the *Guide Specification for Vessel Collision Design of Highway Bridges*
 - GS Foreword: *“In navigable waterway areas where vessel collision by merchant ships and barges may be anticipated, bridge structures shall be designed to prevent collapse of the superstructure by considering the size and type of the vessel, available water depth, vessel speed, and structure response in accordance with the Guide Specification criteria.”*

Guide Specification and Commentary for Vessel Collision Design of Highway Bridges

Volume I: Final Report

February 1991

American Association of
State Highway and
Transportation
Officials



Intro / Purpose of Vessel Collision Design

- Applicability
 - All bridges crossing waterways with commercial barge and/or ship traffic
 - Normal merchant vessels: Steel-hulled ship or barge vessels
 - Bridges crossing waterways with federal or state-defined navigation channels
- Not Applicable:
 - Ships smaller than 1000 DWT
 - Recreational vessels
 - Special purpose vessels, wood, or fiberglass vessels

Guide Specification and Commentary for Vessel Collision Design of Highway Bridges

Volume I: Final Report

February 1991

American Association of
State Highway and
Transportation
Officials



Intro / Purpose of Vessel Collision Design

- Guide Specifications (GS)
 - Established criteria for design/analysis of bridges subject to vessel collision.
 - 2009: Second Edition published by AASHTO
 - 2010 Interim Revisions released
 - Superseded by *AASHTO LRFD Bridge Design Specifications (LRFD)*

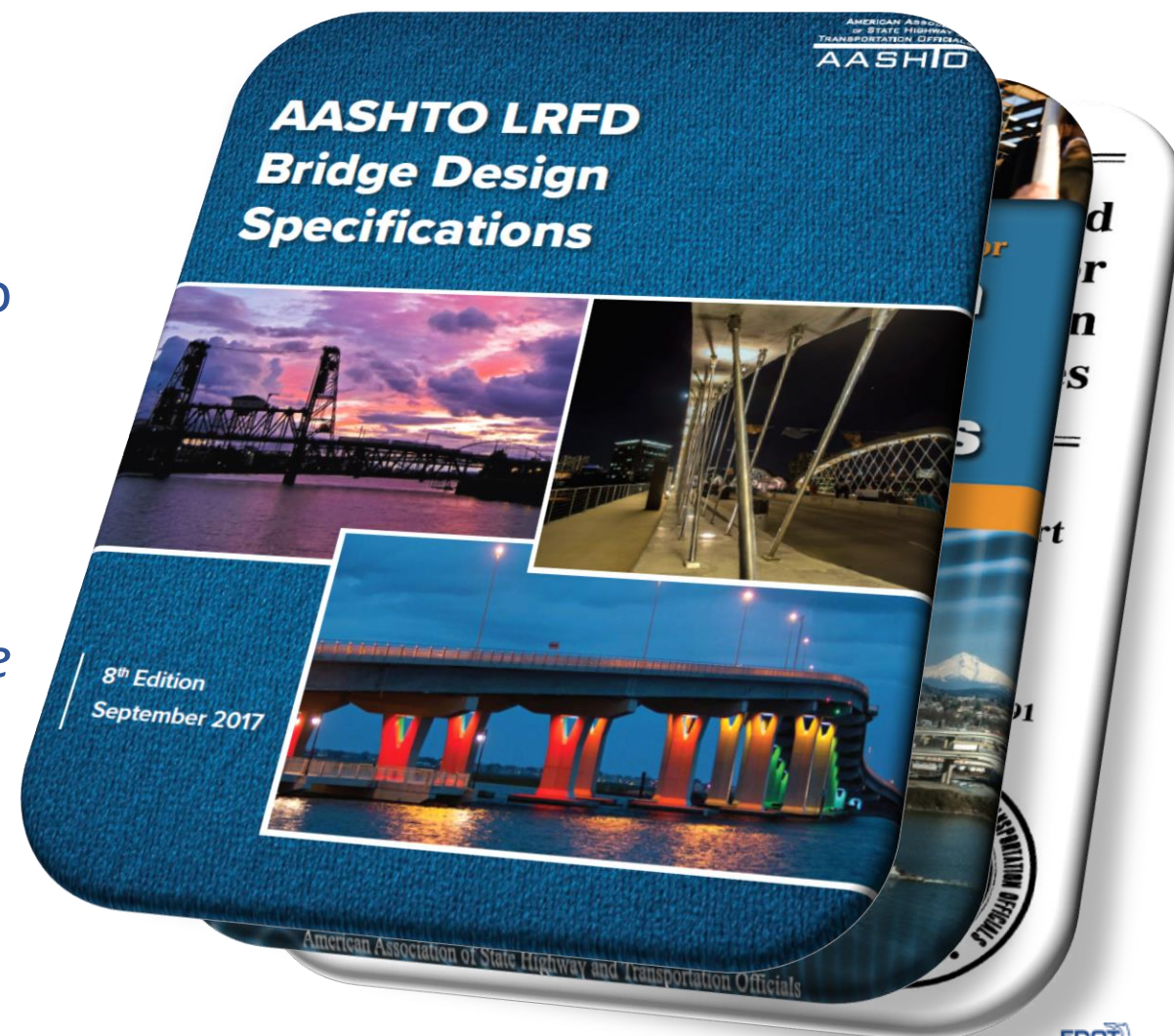

Vessel Collision Design Criteria

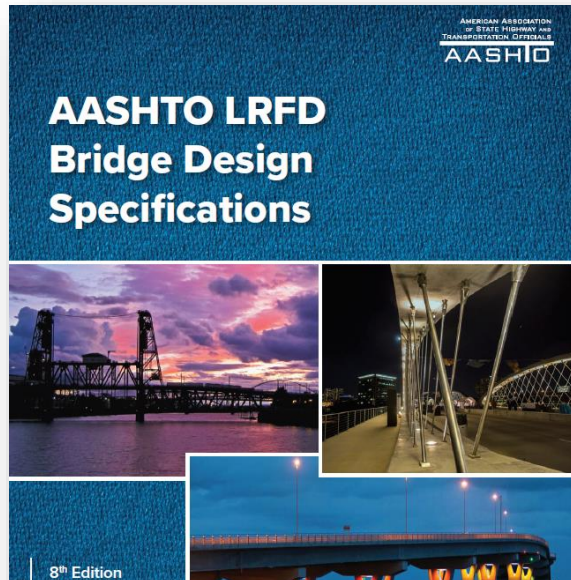

3.14—VESSEL COLLISION: CV

3.14.1—General

The provisions of this Article apply to the accidental collision between a vessel and a bridge. These provisions may be revised as stated in Article 3.14.16 to account for intentional collisions.

All bridge components in a navigable waterway crossing, located in design water depths not less than 2.0 ft, shall be designed for vessel impact.

The minimum design impact load for substructure design shall be determined using an empty hopper barge drifting at a velocity equal to the yearly mean current for the waterway location. The design barge shall be a single 35.0-ft × 195-ft barge, with an empty displacement of 200 tons, unless approved otherwise by the Owner.

C3.14.1

Intentional collision between a vessel and a bridge may be considered when conducting security studies.

The determination of the navigability of a waterway is usually made by the U.S. Coast Guard.

The requirements herein have been adapted from the AASHTO *Guide Specifications and Commentary for Vessel Collision Design of Highway Bridges (1991)* using the Method II risk acceptance alternative, and modified for the second edition (2009). The 1991 Guide Specifications required the use of a single vessel length overall (*LOA*) selected in accordance with the Method I criteria for use in estimating the geometric probability and impact speed to represent all vessel classifications. This was

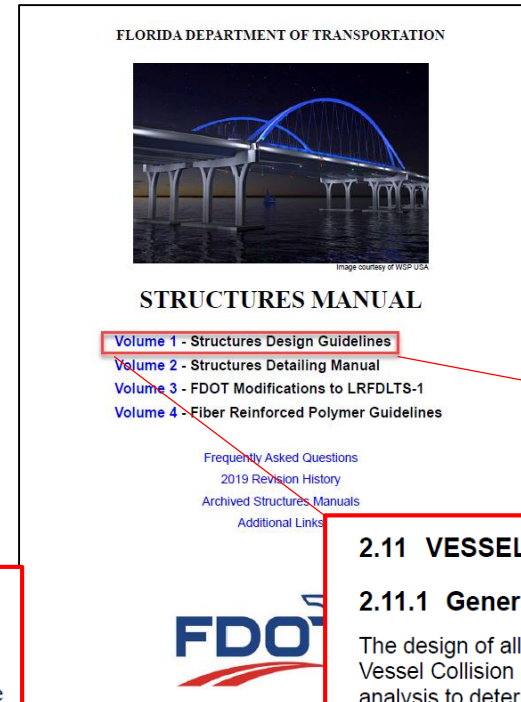

2.11 VESSEL COLLISION [3.14]

2.11.1 General [3.14.1]

The design of all bridges over navigable waters must include consideration for possible Vessel Collision (usually from barges or ocean going ships). Conduct a vessel risk analysis to determine the most economical method for protecting the bridge. The marine vessel traffic characteristics are available for bridges located across inland waterways and rivers carrying predominately barges. The number of vessel passages and the vessel sizes are embedded as an integral part of the Department's Vessel Collision Risk Analysis Software. The vessel traffic provided is based on the year 2000 and an automatic traffic escalation factor is provided by the software for the various past points which one selects. It is recommended that the engineer compare the total vessel trip count being used in the risk analysis with the latest total vessel trip count provided for the appropriate section of waterway as published by the Army Corps. The escalation factor

Annual Frequency of Collapse (AFC)

$$AFC = (N)(PA)(PG)(PC)(PF)$$



N = Annual **number of vessels**, classified by type, size, and loading condition, that utilize the channel

PA = **Probability of Aberrancy** = Probability based on navigation conditions at the bridge site

PG = **Geometric Probability** = Probability a vessel will hit a bridge pier or superstructure component if it is aberrant in vicinity of bridge

PC = **Probability of Collapse** = Probability bridge will collapse if struck by aberrant vessel

PF = **Protection Factor** = Adjustment to AF for full or partial protection of selected bridge components (typically 1.0 for FDOT projects)

FDOT Vessel Collision Risk Analysis Program

VESSEL COLLISION RISK ANALYSIS v4.1



Vessel Collision Risk Analysis for Substructure Design AASHTO LRFD BDS Method II

© 2018 Florida Department of Transportation

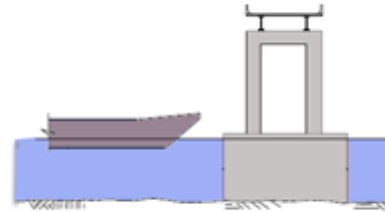

Table of Contents

1. Navigable Channel Characteristics and Vessel Traffic PastPoint Data
2. Pier Characteristics
3. Vessel Fleet Characteristics
4. Vessel Characteristics per Vessel Group (i) per Pier (j)
5. Probability of Aberrancy (PA)
6. Geometric Probability (PG)
7. Probability of Collapse (PC)
8. Annual Frequency of Collapse (AFC)
9. H.pier values that gives an equal AFC distribution per pier
10. Summary
11. Importance Classification (IC)
12. Minimum Barge Collision Force on Pier (PB)

[Reference & Help File](#)

[Florida Vessel Data File](#)

*Vessel Collision Risk Analysis
(MathCad) program developed
as a tool to perform the
AASHTO Method II Analysis*

*Ref.: GS Article 4.1.2.2 &
AASHTO LRFD Article 3.14*

FDOT Vessel Collision Risk Analysis Program

Water and Bridge Characteristics	Symmetrical?			
Water approach depths about longitudinal bridge axis	Yes	Yes	No	No
Water depths, pier locations, pier widths, & pier strengths about channel centerline	Yes	No	Yes	No
ANALYSIS TYPE REQUIRED	1	2	3	4

Analysis Type	Number of Runs	'SymmetricalBridge'	'Vessel Direction'
1	1	'Yes'	'Both'
2	2 ★	'No'	'Both'
3	2 ★	'Yes'	'Up' / 'Down'
4	4 ★	'No'	'Up' / 'Down'

★ Sum the individual AFC for reach analysis run to determine the Total AFC

FDOT Vessel Collision Risk Analysis Program

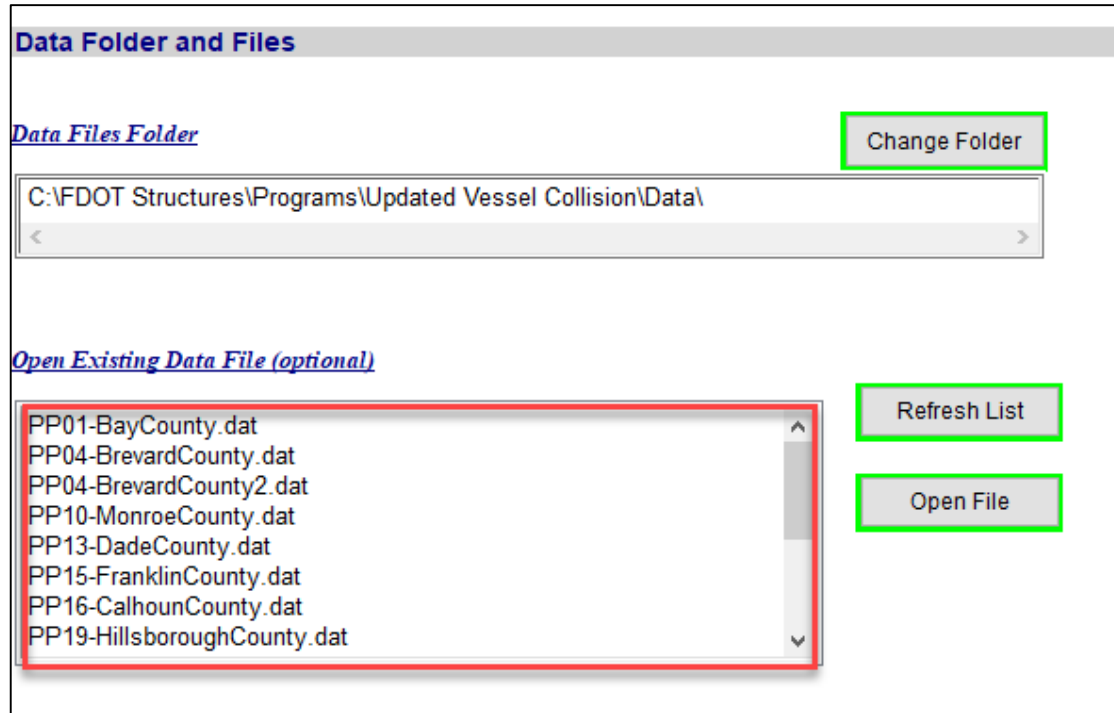

- Past Point data from *Synthesizing Commercial Shipping from Available Data for Vessel Collision Design (1999)* include various vessel characteristics
- Past Point Data Files included in the program provide initial data for:
 - Channel Width
 - Angle of Channel Turn
 - Waterway Region (Straight, Transition, or Turn/Bend)
 - Waterway current components (parallel and perpendicular)
- Update data specific to site

Important to note: Counties may have multiple Past Points, and Existing Past Point Data Files are not available for all past point locations. Use Past Point 53 Data File for sites not listed.

Section 1: Navigable Channel Characteristics and Vessel Traffic Past Point Data

Channel Characteristics

C = Channel width as shown on GS Figures 4.2.1-1, 4.2.1-2, and 8.5.1-1.
(standard intracoastal waterway channel width = 125 feet) (p.2)

feet

θ = Angle of channel turn or bend as shown in GS Figure 4.8.3.2-1 (see PA, p.17).

degrees

Region = Waterway Region as shown in GS Figure 4.8.3.2-1 (see PA, p.17)

Straight
 Transition
 Turn/Bend

V_c = Waterway current component acting parallel to the vessel transit path. Determine direction and velocity for each site. A minimum velocity of 0.4 knots is recommended (see PA, p.17).

knot

V_{XC} = Waterway current component acting perpendicular to the vessel transit path. (see V, p.15)

knot

R_D = Correction factor for vessel traffic density: (1.0 = low, 1.3 = average, 1.6 = high)

Low
 Average
 High

Section 1: Navigable Channel Characteristics and Vessel Traffic Past Point Data

- Channel Location & Alignment

- Existing bridge with designated channel?
- Defined channel used by USCG or USACOE?
- Consider waterway characteristics
- Is there a history of accidents?

- Channel Width

- Consult USCG Bridge Guide Clearances
- Consider Existing, Upstream, and Downstream clearances
- What are needs for existing and future vessels?
- History of accidents at existing bridges or nearby bridges?

No.	Waterway	Bridge Type	Horizontal Clearance	Vertical Clearance	Reference Plane
<u>41</u>	St. Johns River, FL				
	FEC Railroad Bridge to Green Cove Springs	Fixed or vertical lift Swing or bascule	200 ft. 200 ft.	65 feet 21 feet (closed)	MHW MHW
	Green Cove Springs to Lake Harney	Fixed or vertical lift. Swing or bascule	100 ft. 100 ft.	45 feet 10 feet (closed)	MHW MHW

• *Owner Responsibility: For Design-Build Projects, Channel Width should be provided in the RFP.*

Section 1: Navigable Channel Characteristics and Vessel Traffic Past Point Data

Channel Characteristics

C = Channel width as shown on GS Figures 4.2.1-1, 4.2.1-2, and 8.5.1-1.
(standard intracoastal waterway channel width = 125 feet) (p.2)

feet

θ = Angle of channel turn or bend as shown in GS Figure 4.8.3.2-1 (see PA, p.17).

degrees

Region = Waterway Region as shown in GS Figure 4.8.3.2-1 (see PA, p.17)

Straight
 Transition
 Turn/Bend

V_c = Waterway current component acting parallel to the vessel transit path. Determine direction and velocity for each site. A minimum velocity of 0.4 knots is recommended (see PA, p.17).

knot

V_{XC} = Waterway current component acting perpendicular to the vessel transit path. (see V, p.15)

knot

R_D = Correction factor for vessel traffic density: (1.0 = low, 1.3 = average, 1.6 = high)

Low
 Average
 High

Section 1: Navigable Channel Characteristics and Vessel Traffic Past Point Data

- Angle of Channel Turn or Bend, θ
- Waterway Region: Straight, Transition, or Turn/Bend?

It is important to document the assumptions made for the vessel impact risk analysis. *Owner Responsibility: For Design-Build Projects, these variables should be provided in the RFP.*

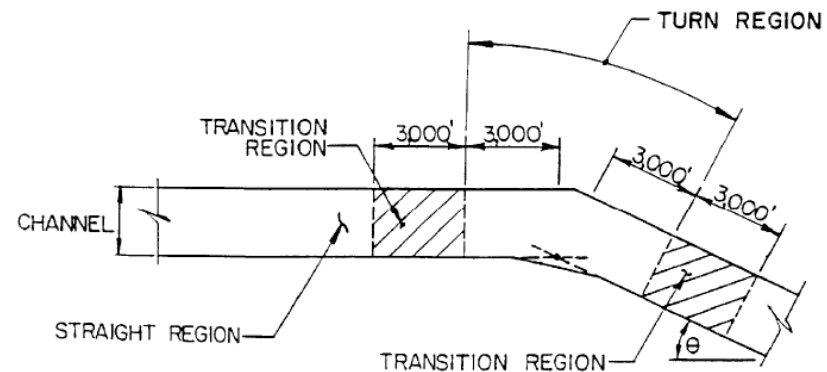
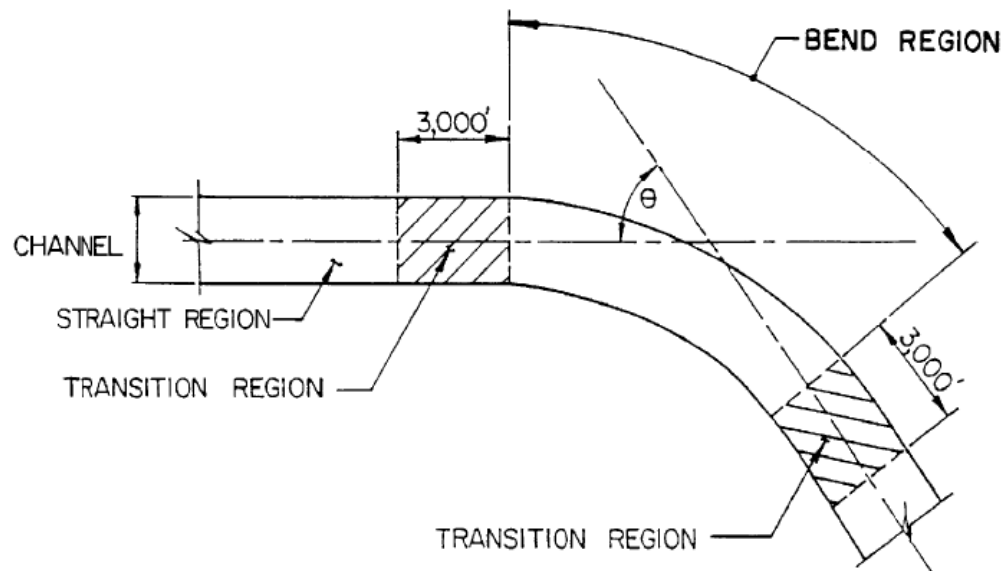
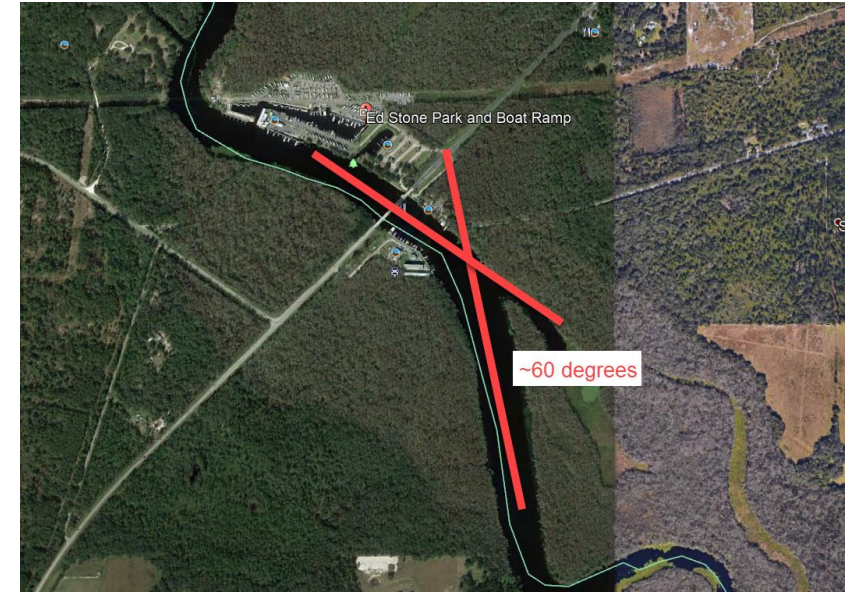

LRFD Fig. 3.14.5.2.3-1

Section 1: Navigable Channel Characteristics and Vessel Traffic Past Point Data

Channel Characteristics

C = Channel width as shown on GS Figures 4.2.1-1, 4.2.1-2, and 8.5.1-1.
(standard intracoastal waterway channel width = 125 feet) (p.2)

feet

θ = Angle of channel turn or bend as shown in GS Figure 4.8.3.2-1 (see PA, p.17).

degrees

Region = Waterway Region as shown in GS Figure 4.8.3.2-1 (see PA, p.17)

Straight
 Transition
 Turn/Bend

V_c = Waterway current component acting parallel to the vessel transit path. Determine direction and velocity for each site. A minimum velocity of 0.4 knots is recommended (see PA, p.17).

knot

V_{XC} = Waterway current component acting perpendicular to the vessel transit path. (see V, p.15)

knot

R_D = Correction factor for vessel traffic density: (1.0 = low, 1.3 = average, 1.6 = high)

Low
 Average
 High

Section 1: Navigable Channel Characteristics and Vessel Traffic Past Point Data

- Current
 - Include as part of the Bridge Hydraulic Report
 - NOAA “Tidal Current Tables” & “Tidal Current Charts and Nautical Charts”
 - Use Annual Average Velocity (not design, base, greatest flood event)
 - Determine the direction of flow
 - Tidal waterways will have ebb and flood currents. Single design current applicable?
 - **Owner Responsibility: For Design-Build Projects, these variables should be provided in the RFP.**

Dames Point, 0.23 n.mi. ESE of (SJR0301) Depth: 31 feet

LAT/LON: 30.3865° N 81.5538° W

Note: Depth is measured below chart datum.

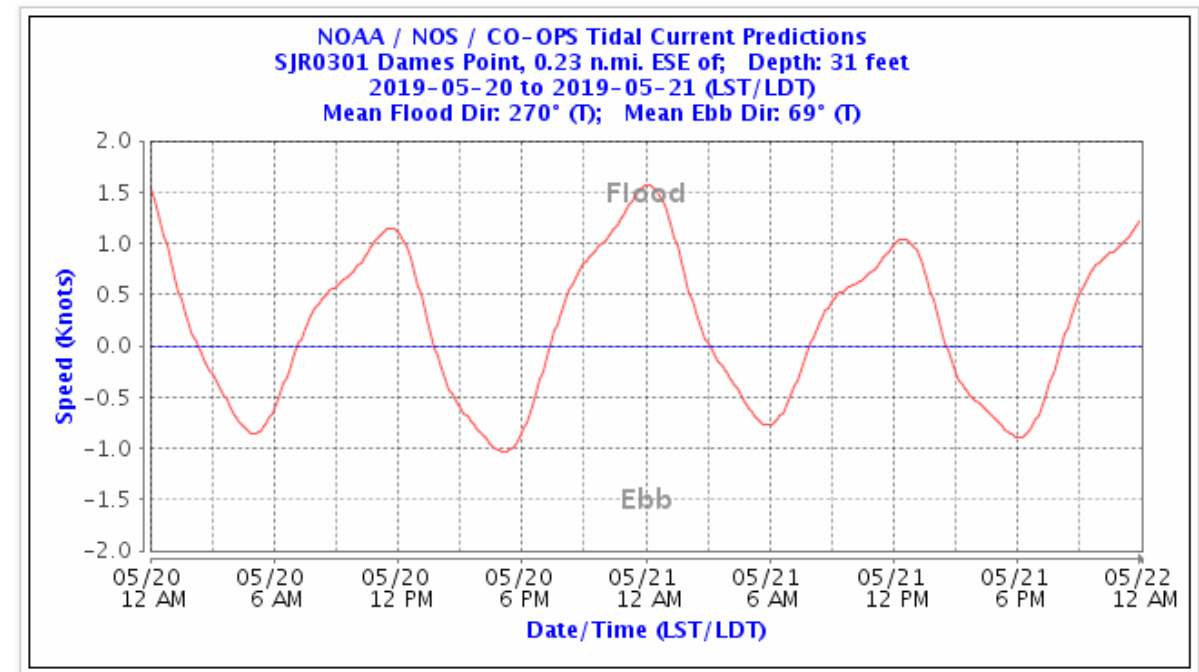

Section 1: Navigable Channel Characteristics and Vessel Traffic Past Point Data

Channel Characteristics

C = Channel width as shown on GS Figures 4.2.1-1, 4.2.1-2, and 8.5.1-1.
(standard intracoastal waterway channel width = 125 feet) (p.2)

feet

θ = Angle of channel turn or bend as shown in GS Figure 4.8.3.2-1 (see PA, p.17).

degrees

Region = Waterway Region as shown in GS Figure 4.8.3.2-1 (see PA, p.17)

V_c = Waterway current component acting parallel to the vessel transit path. Determine direction and velocity for each site. A minimum velocity of 0.4 knots is recommended (see PA, p.17).

knot

V_{XC} = Waterway current component acting perpendicular to the vessel transit path. (see V, p.15)

knot

R_D = Correction factor for vessel traffic density: (1.0 = low, 1.3 = average, 1.6 = high)

Section 1: Navigable Channel Characteristics and Vessel Traffic Past Point Data

- Correction Factor for Vessel Traffic Density, R_D

- Based on ship/barge traffic density level in waterway in immediate vicinity of bridge.
- Can be subjective.
- Suggested to bracket two extremes, evaluate sensitivity of variable on AFC calculation.
- *Owner Responsibility: For Design-Build Projects, these variables should be provided in the RFP.*

- Low density—vessels rarely meet, pass, or overtake each other in the immediate vicinity of the bridge:

$$R_D = 1.0 \quad (3.14.5.2.3-7)$$

- Average density—vessels occasionally meet, pass, or overtake each other in the immediate vicinity of the bridge:

$$R_D = 1.3 \quad (3.14.5.2.3-8)$$

- High density—vessels routinely meet, pass, or overtake each other in the immediate vicinity of the bridge:

$$R_D = 1.6 \quad (3.14.5.2.3-9)$$

Section 1: Navigable Channel Characteristics and Vessel Traffic Past Point Data

Vessel Traffic Data

*Past Point Number (PPN) enter 1 – 52 53 = user defined
To determine PastPointNumber,, click on this link*

[View Past Point Maps](#)

Vessel direction(s) to use in the analysis, (Direction of vessel traffic is not related to waterway current.)

Up
Down
Both

V_{\min} = *The minimum impact speed, V_{\min} , at 3xLOA. (1 knot minimum)*

knot

Vessel Traffic Growth Factor applied to the Number of Trips

Section 1: Navigable Channel Characteristics and Vessel Traffic Past Point Data

- FDOT Past Point Data
 - Primary source for vessel fleet data
 - Is Past Point Data still accurate?
 - Compare to results of Vessel Survey
 - Do physical barriers exist which eliminate vessels?
 - Future plans that affect shipping
 - Determine if fleet characteristics should be modified
- Vessel Survey
 - Should address all types of vessels
 - Typically a requirement for USCG Permit
- ***Owner Responsibility: For Design-Build Projects, this data should be clarified in the RFP.***

SYNTHESIZING COMMERCIAL SHIPPING (BARGE/TUG TRAINS) FROM AVAILABLE DATA FOR VESSEL COLLISION DESIGN

State Project No. 99700-3596-119
HPR Study No. 0510841
Contract No. BB-489

Principal Investigator:
Ton-Lo Wang, Ph.D., P.E.
Co-Principal Investigator:
Chunhua Liu, Ph.D.

Department of Civil & Environmental Engineering
Florida International University
Miami, FL 33199

Prepared for:
Research Center
Florida Department of Transportation
Tallahassee, FL 32399

Modified by Larry Sessions 12-17-99
Revision to Block Coefficients and Traffic Growth Factors

Section 1: Navigable Channel Characteristics and Vessel Traffic Past Point Data

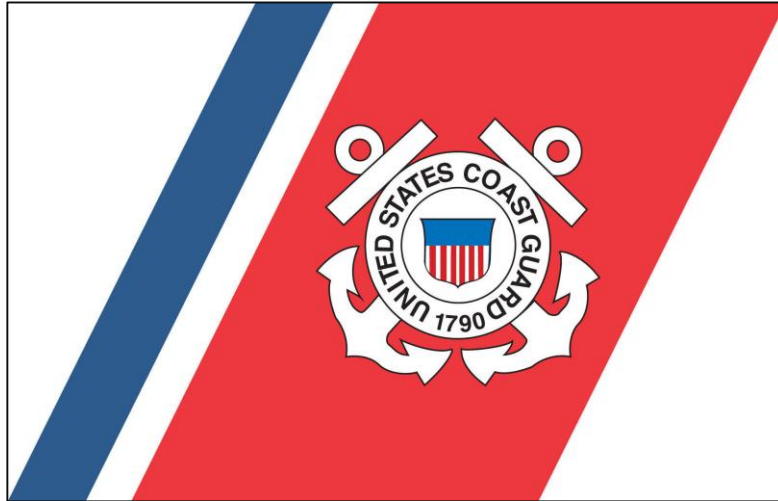

- Permitting Agencies & Resources
 - Consult USACOE & USCG District Offices
- Contact Local Industries
 - Port Authorities & Marinas
 - Pilot Associations & Merchant Marine Organizations
 - Other entities adjacent to water

Section 1: Navigable Channel Characteristics and Vessel Traffic Past Point Data

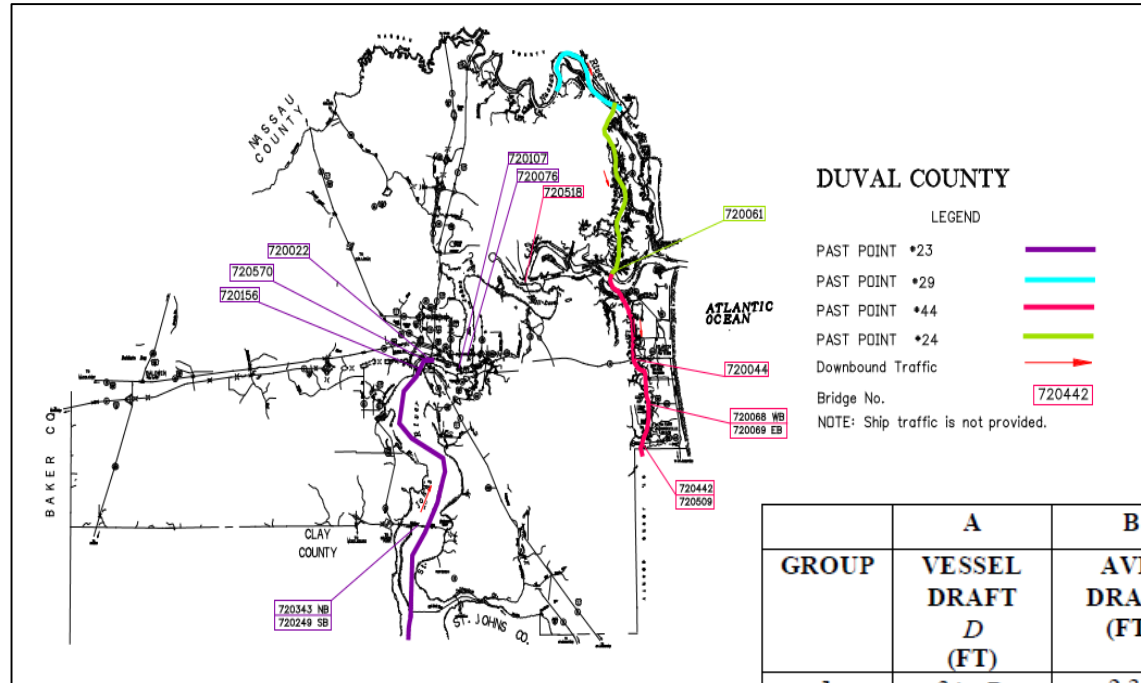

CY2000 Vessel Group Traffic UPBOUND

Bridge NO: 740055
Past the point: 29

	A	B	C	D	E	F	G	H	I
GROUP	VESSEL DRAFT <i>D</i> (FT)	AVE. DRAFT (FT)	NUMBER OF BARGES	NUMBER OF BARGES PER TRIP	NUMBER OF TRIPS	AVE. WIDTH (FT)	AVE. LENGTH (FT)	AVE. SINGLE UNIT DISPLACEMENT (TON)	TUG TYPE Or DWT (TONNE)
1	$3 \geq D$	2.34	69.66	1.	69.66	44.01	232.03	824.40	SMALL
2	$6 \geq D > 3$	5.51	162.88	1.	162.88	48.43	258.14	2276.64	MED
3	$9 \geq D > 6$	8.21	97.32	1.	97.32	35.84	159.34	1535.80	MED
4	$12 \geq D > 9$	10.16	46.10	1.	46.10	40.03	209.71	3011.67	LARGE
5	Free Tugs	7.90			140.34	22.98	66.67	418.56	
6	Self Propelled	6.29			7.17	33.86	156.31	1192.55	550.69
Σ			375.96		523.47				

Section 1: Navigable Channel Characteristics and Vessel Traffic Past Point Data

Vessel Traffic Data

Past Point Number (PPN) enter 1 – 52 53 = user defined
To determine PastPointNumber,, click on this link

[View Past Point Maps](#)

Vessel direction(s) to use in the analysis, (Direction of vessel traffic is not related to waterway current.)

V_{min} = The minimum impact speed, V_{min} , at 3xLOA. (1 knot minimum)

 knot

Vessel Traffic Growth Factor applied to the Number of Trips

Minimum impact speed, typically considered from yearly mean flood current. Minimum impact speed = 1 knot.

This field is a user-defined field to adjust the Number of Trips (N_{trips}) per Vessel per Year to account for future growth.

Often consider Both directions, unless the evaluation necessitates consideration of either Up or Down direction. For example:

- Considering different up/downstream transit velocities
- Different water depths either side of longitudinal bridge axis

Section 2: Pier Characteristics

Do you want the program to mirror the Pier Data? (e.g. Are both the bridge piers and channel depths symmetric about the channel centerline?)

No
Yes

#Piers = Number of Piers entered, if SymmetricalBridge = 1 (Yes), the pier values will be mirrored about the channel centerline

x_{pier} = Distance from centerline of channel to centerline of the pier (must be in ascending values, use + values if using symmetrical data).

B_{pier} = Bridge pier width, considering angle between channel and bridge centerline.

H_{pier} = Pier Resistance, Resistance of the pier to a horizontal force, also referred to as Ultimate Transverse Pier Strengths

Pier #	1	2	3	4	5	6	7	8	9	10	11	12	13	14
x_{pier}														
B_{pier}														
D_{water}														
H_{pier}														

Section 2: Pier Characteristics

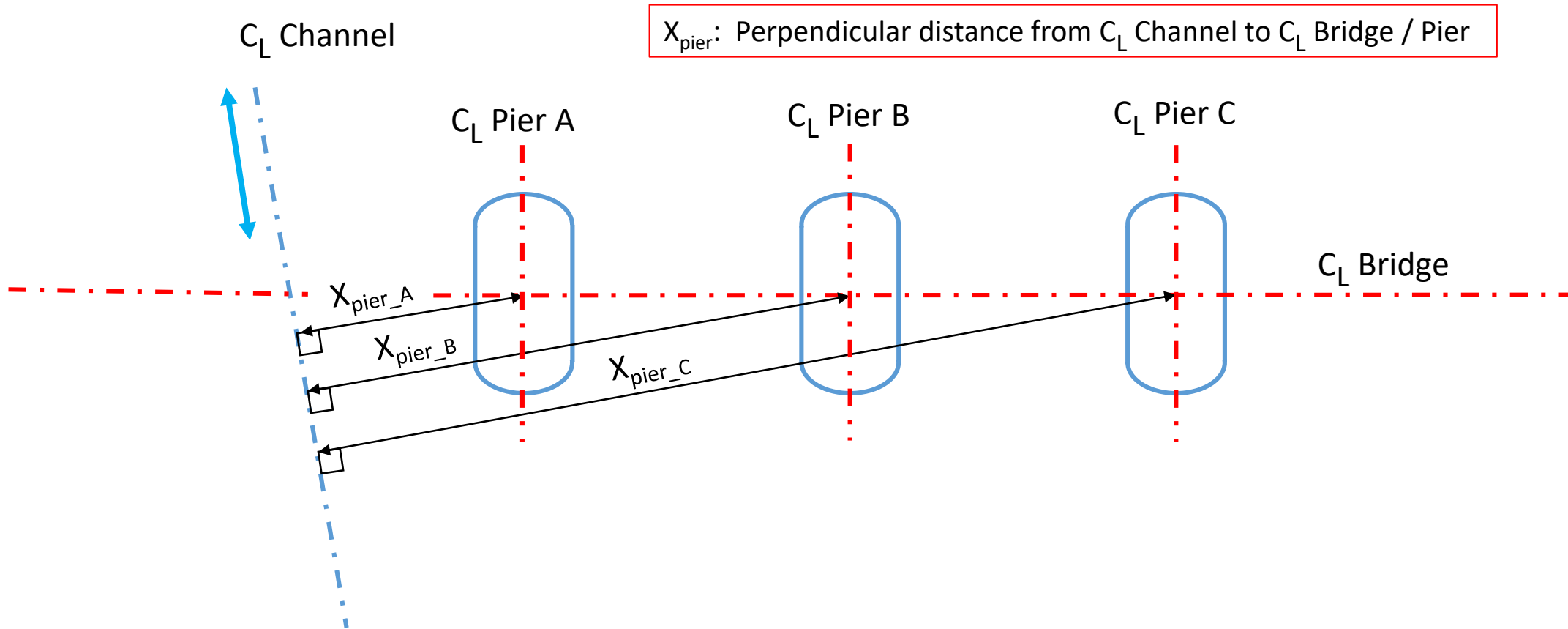

Section 2: Pier Characteristics

Do you want the program to mirror the Pier Data? (e.g. Are both the bridge piers and channel depths symmetric about the channel centerline?)

No
Yes

#Piers = Number of Piers entered, if SymmetricalBridge = 1 (Yes), the pier values will be mirrored about the channel centerline

x_{pier} = Distance from centerline of channel to centerline of the pier (must be in ascending values, use + values if using symmetrical data).

B_{pier} = Bridge pier width, considering angle between channel and bridge centerline.

H_{pier} = Pier Resistance, Resistance of the pier to a horizontal force, also referred to as Ultimate Transverse Pier Strengths

Pier #	1	2	3	4	5	6	7	8	9	10	11	12	13	14
x_{pier}														
B_{pier}														
D_{water}														
H_{pier}														

Section 2: Pier Characteristics

Per the *Guide Specifications*:

- “For footings not oriented parallel to the navigation channel, the footing width is increased by the angle of the skew the footing makes with the channel.”
- “Skewed bridge alignments... have a higher risk of vessel collision.”
- It is generally good design practice to orient footings parallel with channel

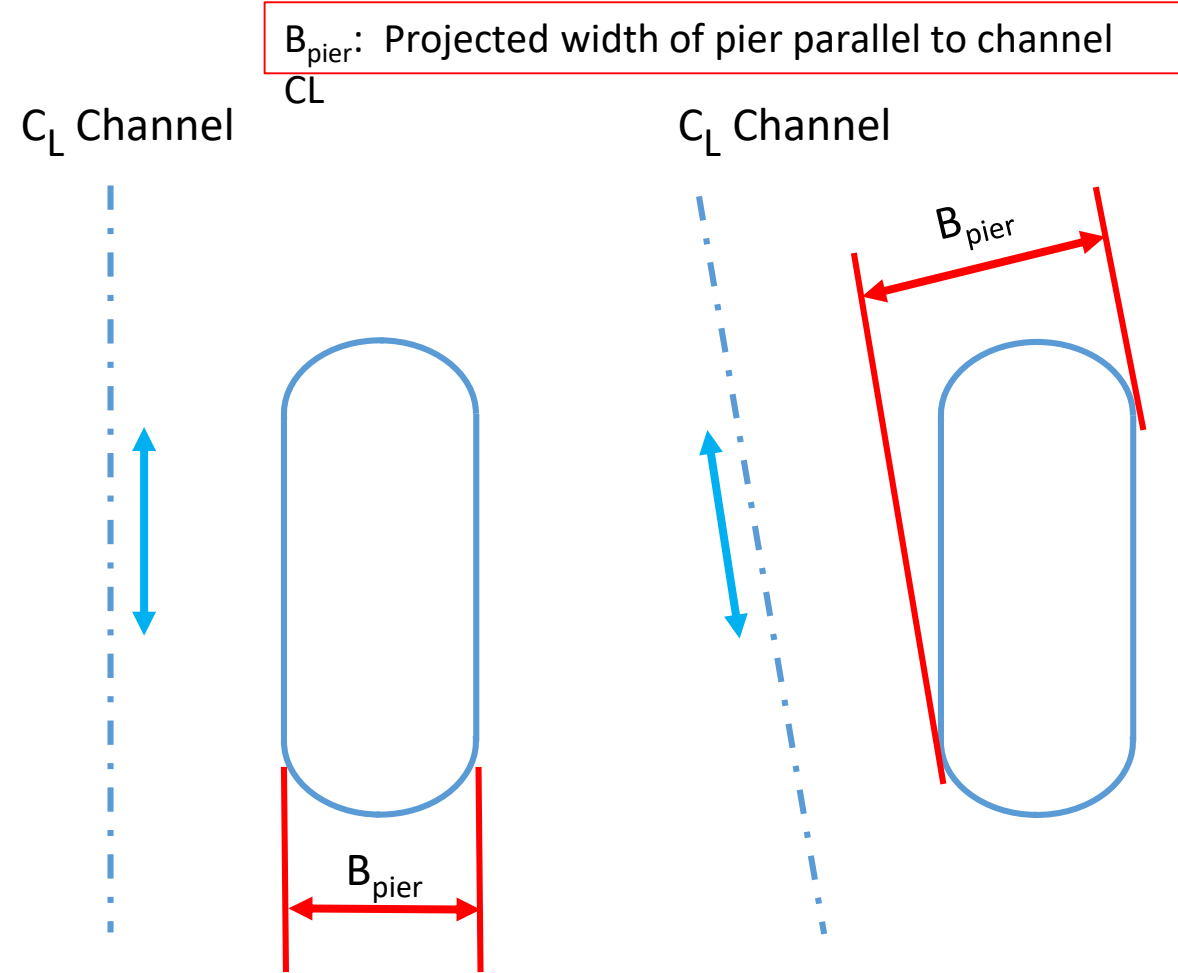

Section 2: Pier Characteristics

Do you want the program to mirror the Pier Data? (e.g. Are both the bridge piers and channel depths symmetric about the channel centerline?)

No
Yes

#Piers = Number of Piers entered, if SymmetricalBridge = 1 (Yes), the pier values will be mirrored about the channel centerline

x_{pier} = Distance from centerline of channel to centerline of the pier (must be in ascending values, use + values if using symmetrical data).

B_{pier} = Bridge pier width, considering angle between channel and bridge centerline.

H_{pier} = Pier Resistance, Resistance of the pier to a horizontal force, also referred to as Ultimate Transverse Pier Strengths

Pier #	1	2	3	4	5	6	7	8	9	10	11	12	13	14
x_{pier}														
B_{pier}														
D_{water}														
H_{pier}														

Section 2: Pier Characteristics

- Water depths

- Determine depths at bridge and upstream/downstream
- Water datum – Typically Annual Mean High Water, possible adjustments due to seasonal flooding
- For risk analysis – neglect scour
 - Note: Scour is considered for modeling the pier in design
- Assume dredged depth for federally maintained channels

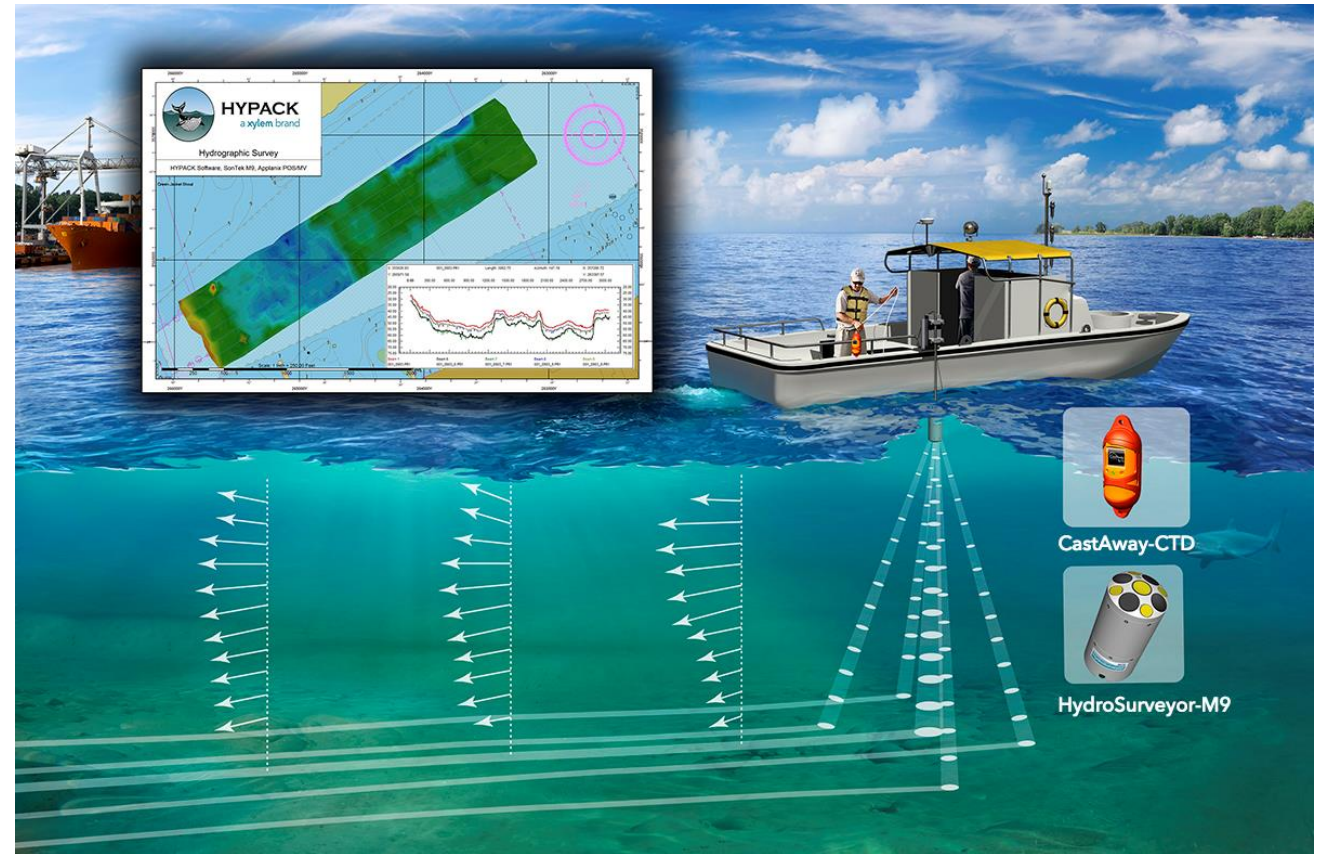

Section 2: Pier Characteristics

Do you want the program to mirror the Pier Data? (e.g. Are both the bridge piers and channel depths symmetric about the channel centerline?)

No
Yes

#Piers = Number of Piers entered, if SymmetricalBridge = 1 (Yes), the pier values will be mirrored about the channel centerline

x_{pier} = Distance from centerline of channel to centerline of the pier (must be in ascending values, use + values if using symmetrical data).

B_{pier} = Bridge pier width, considering angle between channel and bridge centerline.

H_{pier} = Pier Resistance, Resistance of the pier to a horizontal force, also referred to as Ultimate Transverse Pier Strengths

Pier #	1	2	3	4	5	6	7	8	9	10	11	12	13	14
x_{pier}														
B_{pier}														
D_{water}														
H_{pier}														

Section 2: Pier Characteristics

- Pier Resistance, H_{pier}
 - Defined by the user
 - Analysis considers this pier resistance in the AFC calculation
 - Involves an iterative process to satisfy AFC requirements for piers and to establish the Return Period
 - Program now calculates “theoretical” pier resistances providing for an equal risk distribution (i.e. AFC per pier – see Section 9 in presentation)
 - However, pier resistances should be grouped for uniformity in pier design and allow for practical construction considerations
 - Update pier resistance (H_{pier}) based on these groupings

Section 3: Vessel Fleet Characteristics

- Define vessel lengths, drafts, number of trips, and weights
- Differentiate between upbound and downbound traffic
- Typically from Past Point Data

3. Vessel Fleet Characteristics: *(LRFD 3.14.5.1, GS 3.5 & 4.4)*

- Col 1 D_{bs} = Draft of barge or ship
- Col 2 N_{barge} = number of barges long (0 = ships or tug only)
- Col 3 N_{trips} = number of trips per year
- Col 4 B_{bs} = Width of barge/ship
- Col 5 L_{bs} = Length of a single barge/ship
- Col 6 W_{bs} = displacement of barge/ship (ship displacement shown in section A have been converted from tonnes to tons)
- Col 7 TT = Tug Type, TT = 0, Self Propelled Vessel, TT = 0.5, Tug Only, TT = 1, Barge w/ medium tug, TT = 2, Barge w/ large tug
- Col 8 Dir = Vessel direction(s) to use in the analysis: Up = 0, Down = 1 Both = 2
- Col 9 VT = vessel speed in channel

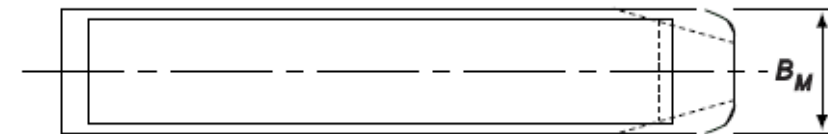
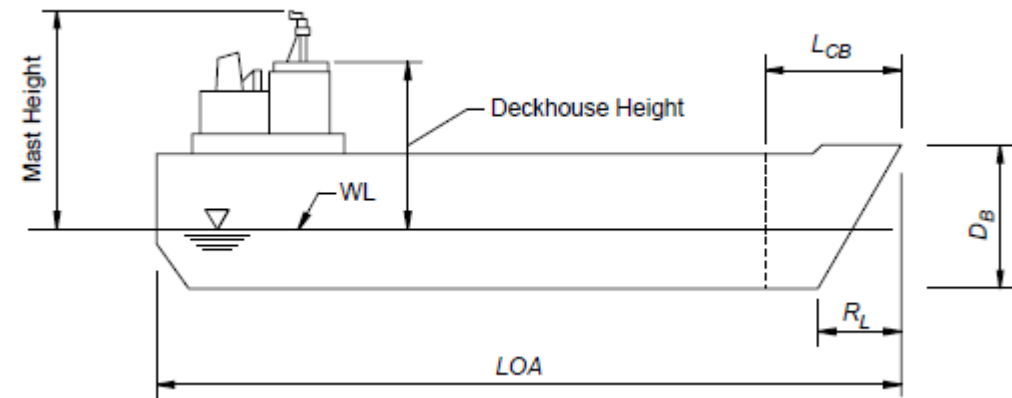

PLAN

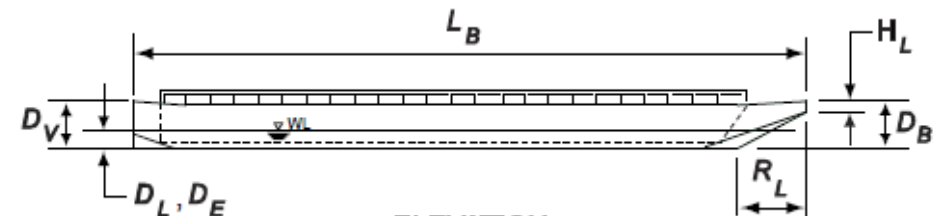

ELEVATION

Section 3: Vessel Fleet Characteristics

Data Sources

- FDOT Past Point Data
- Permitting Agencies
 - USACOE & USCG
 - Waterborne Commerce Statistics Center
- Local Industries (ports, marinas, tug/barge companies, merchant marine organizations, pilot associations, etc.)
- Vessel Survey

Section 3: Vessel Fleet Characteristics

Transit Velocity

- Vessel velocity in channel
- High variability due to:
 - Pilot's experience and judgement
 - Power of vessel or tugboat
 - Weather
 - Traffic
 - Channel characteristics
 - Vessel loading
- Guidance provided in *"Synthesizing Commercial Shipping (Barge/Tug Trains) From Available Data for Vessel Collision Design"* (Florida Commercial Shipping Report, FCSR)

Section 3: Vessel Fleet Characteristics

Transit Velocity

- Recommendations from Florida Commercial Shipping Report Table 6
- Adjustments to velocity
 - Loaded tug/barge = -1 knot
 - Narrow canals/restricted waterways
 - -1 knot for tug/barge
 - -2 knots for self-propelled
 - Annual mean water current velocity
 - +/- for upbound/downbound traffic

Table 6.
Recommended Vessel Transit Velocity

Vessel Type	Operation Condition	Recommended Velocity (knot)
Barge/Tug Train	Straight Navigation Channel and Clear Traffic	7 ^A
	Curve Navigation Channel and/or Crowded Traffic	6 ^A
Self-propelled Vessel (majority: passenger vessels)	Straight Navigation Channel and Clear Traffic	10 ^A
	Curve Navigation Channel and/or Crowded Traffic	8 ^A
Free Tug	Straight Navigation Channel and Clear Traffic	10 ^A
	Curve Navigation Channel and/or Crowded Traffic	8 ^A

Section 3: Vessel Fleet Characteristics

Transit Velocity

- Program defaults all transit velocities to 7 knots
 - FDOT considering new guidance for transit velocities
- Manually overwrite transit velocities for upbound and downbound vessels based on site-specific characteristics

+

	<u>Col 1</u>	<u>Col 2</u>	<u>Col 3</u>	<u>Col 4</u>	<u>Col 5</u>	<u>Col 6</u>	<u>Col 7</u>	<u>Col 8</u>	
	<i>draft</i>	<i>#barges/Trip</i>	<i>#trips</i>	<i>width</i>	<i>length</i>	<i>displ</i>	<i>tugtype</i>	<i>direction</i>	
fList(PPUp _{PPN}) =	"Dbs"	"Nbarge"	"N"	"Bbs"	"Lbs"	"Wbs"	"TT"	"Dir"	
	2.1	1	19.6	46.8	182.2	619	1	0	
	4.9	1	18.1	65.8	250.6	2659	1	0	
	7.6	1	4.6	42.2	199.4	2021	1	0	
	11.3	1	10.3	46.9	199.8	3342	2	0	
	7	0	26.6	23.6	68.6	242	0.5	0	
	3.5	0	1.4	17.8	70	158	0	0	
	5.6	0	3.2	31.5	135.7	484	0	0	
	9	0	1.8	38	179.2	1389	0	0	

VTpp _{FL.up} =	7	·knot
	7	
	7	
	7	
	7	
	7	
	7	
	7	
	7	
	7	

VTpp _{FL.up} :=	7.84	·knot
	6.84	
	6.84	
	6.84	
	6.84	
	10.84	
	10.84	
	10.84	



Section 4: Vessel Fleet Characteristics per Pier

- Adjustments to vessel characteristics at each pier
 - Modify vessels based on water depth restrictions
 - If tug runs aground, barge collision only
 - If barge runs aground, no collision
 - Reduce impact velocity based on distance from channel (LRFD 3.14.6)

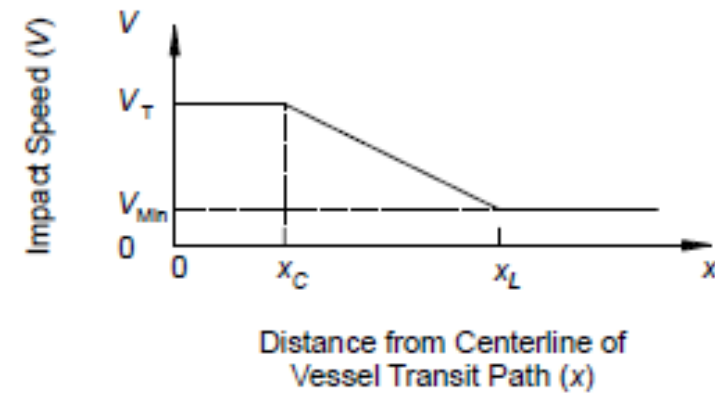

V = design impact speed (ft/s)

V_T = design impact speed (ft/s)

V_{Min} = minimum design impact speed (ft/s)

x = distance to bridge element from centerline of vessel transit path (ft)

x_C = distance to edge of channel from centerline of vessel transit path (ft)

x_L = distance equal to 3 x LOA from centerline of vessel transit path (ft)

Section 5: Probability of Aberrancy (PA)

$$PA = (BR)(RB)(RC)(RXC)(RD) \quad (\text{LRFD Eq. 3.14.5.2.3-1})$$



BR = Aberrancy Base Rate = Estimate of the base rate of vessel aberrancy under ideal conditions

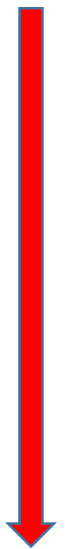

R_B = Bridge Correction Factor = Adjustment to PA based on the proximity of a bridge to a bend in the waterway



R_C = Current Correction Factor = Adjustment to PA based on the velocity of the current component acting parallel to the transit path



R_{XC} = Crosscurrent Correction Factor = Adjustment to PA based on the velocity of the current component acting perpendicular to the transit path



R_D = Traffic Density Correction Factor = Adjustment to PA based on the density of vessel traffic in the region

Section 5: Probability of Aberrancy

- Measure of the risk a vessel is in trouble as a result of pilot error, adverse conditions, and/or mechanical failure
- Human Errors
 - Inattentiveness, drunkenness, miscommunication, rules violations
 - Estimated as 60% to 85% of all vessel accidents
- Adverse Conditions
 - Poor visibility, high density ship traffic, strong currents, channel alignment
 - Significant abnormalities (such as consistent presence of high winds or fog) are not considered in Base Rate
- Mechanical Failures
 - Engine failure, loss of power/steering, poor equipment maintenance

Section 5: Probability of Aberrancy

Base Rate of Aberrancy (BR)

- Based on standard human error and mechanical failures
- $BR = 0.6 \times 10^{-4}$ (ships)
- $BR = 1.2 \times 10^{-4}$ (barges)

Current Correction Factor (R_C)

- $R_C = 1 + V_C/10$
- V_C = Current velocity component parallel to vessel transit path

Crosscurrent Correction Factor (R_{XC})

- $R_{XC} = 1 + V_{XC}$
- V_{XC} = Current velocity component perpendicular to vessel transit path

Section 5: Probability of Aberrancy

Bridge Correction Factor (R_B)

- Based on waterway regions
- $R_B = 1.0$ for Straight Regions
- $R_B = 1 + \theta/90^\circ$ for Transition Regions
- $R_B = 1 + \theta/45^\circ$ for Turn/Bend Regions

Traffic Density Correction Factor (R_D)

- Frequency in which vessels meet or pass each other near bridge
- $R_D = 1.0$ for low (rarely)
- $R_D = 1.3$ for average (occasionally)
- $R_D = 1.6$ for high (routinely)

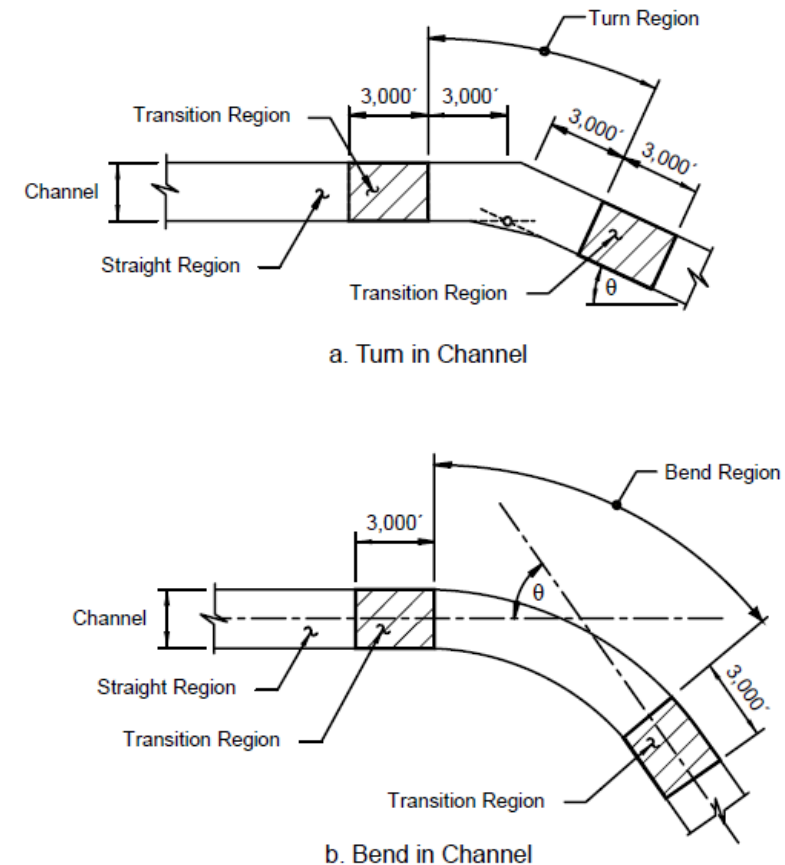

Figure 4.8.3.2-1—Waterway Regions for Bridge Location

Section 6: Geometric Probability (PG)

- Geometric probability that an aberrant vessel will hit the bridge
- Considers vessel dimensions, pier width, water depth, span length, i.a.
- Computed based on a normal distribution of vessel accidents about CL of transit path

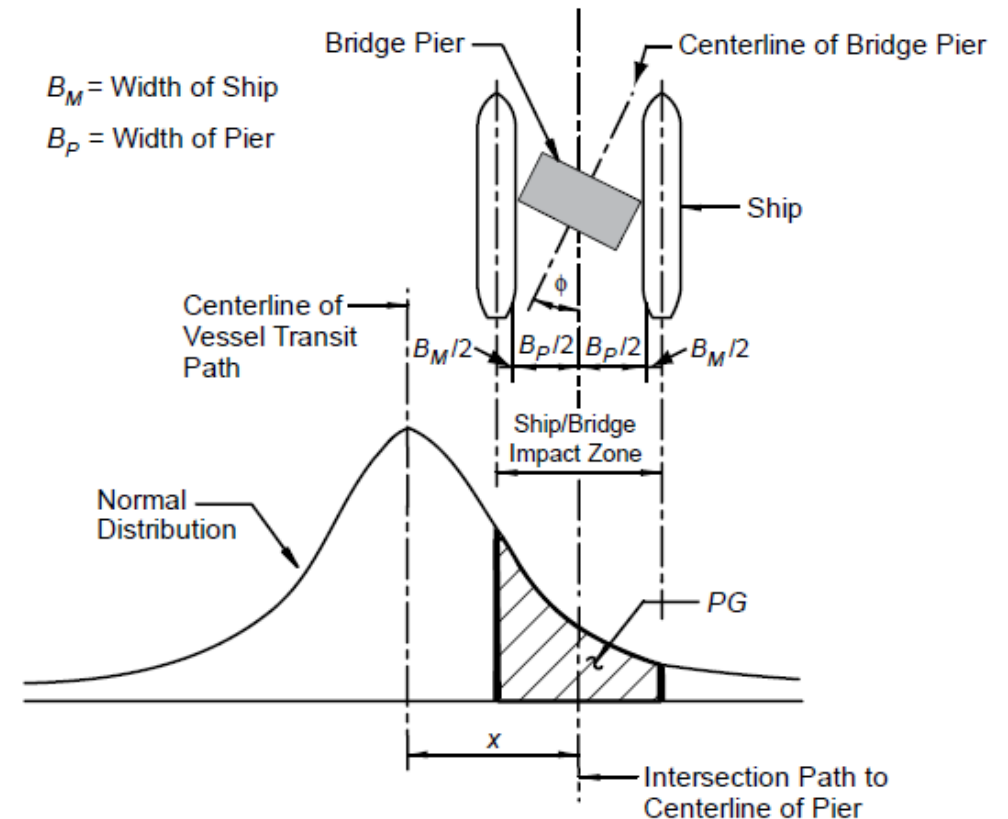
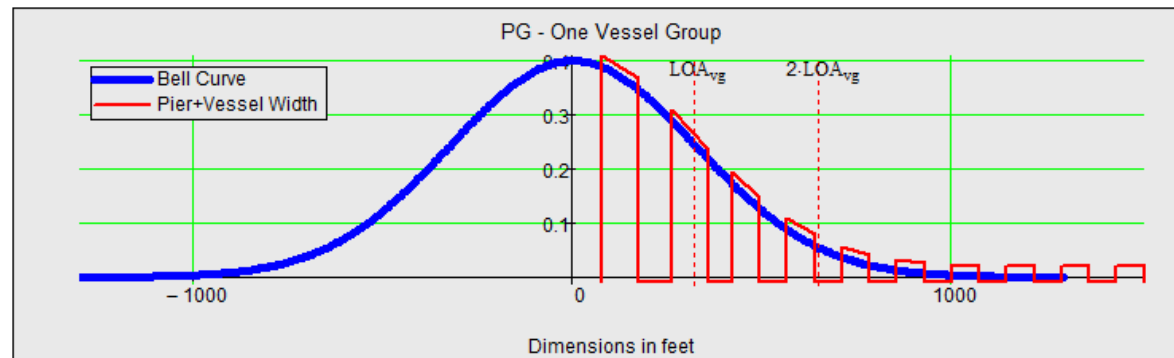

Figure 4.8.3.3-1—Geometric Probability of Pier Collision

Section 7: Probability of Collapse (PC)

- Probability that the bridge will collapse when struck by an aberrant vessel
- Based on Design Impact Force (P) and Bridge Element Horizontal Resistance (H)
- Per LRFD 3.14.5.4:
 - $PC = 0.1 + 9 \cdot (0.1 - H/P)$ for $0.0 \leq H/P < 0.1$
 - $PC = (1/9) \cdot (1 - H/P)$ for $0.1 \leq H/P < 1.0$
 - $PC = 0$ for $H/P \geq 1.0$

Section 7: Probability of Collapse

- Distribution varies linearly from 0.0 to 0.1, and from 0.1 to 1.0
- Subject of ongoing research at University of Florida

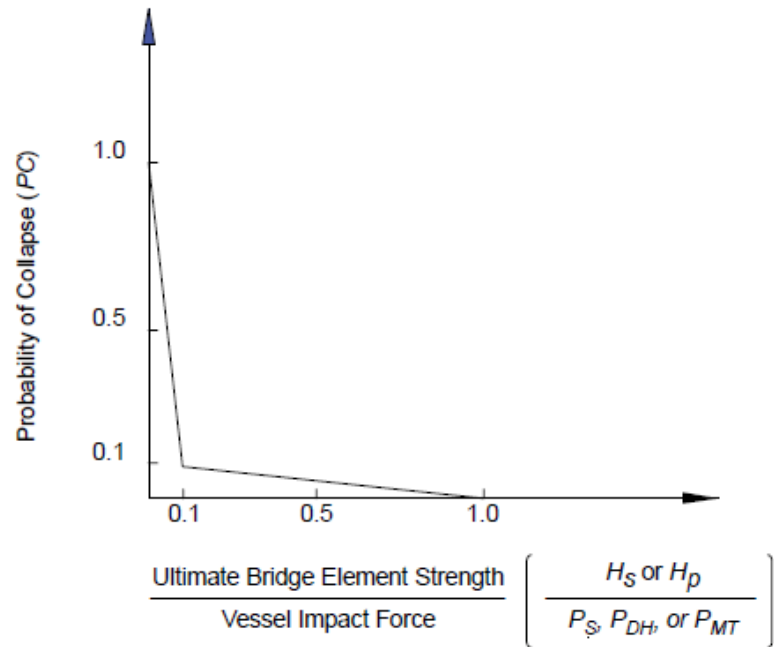
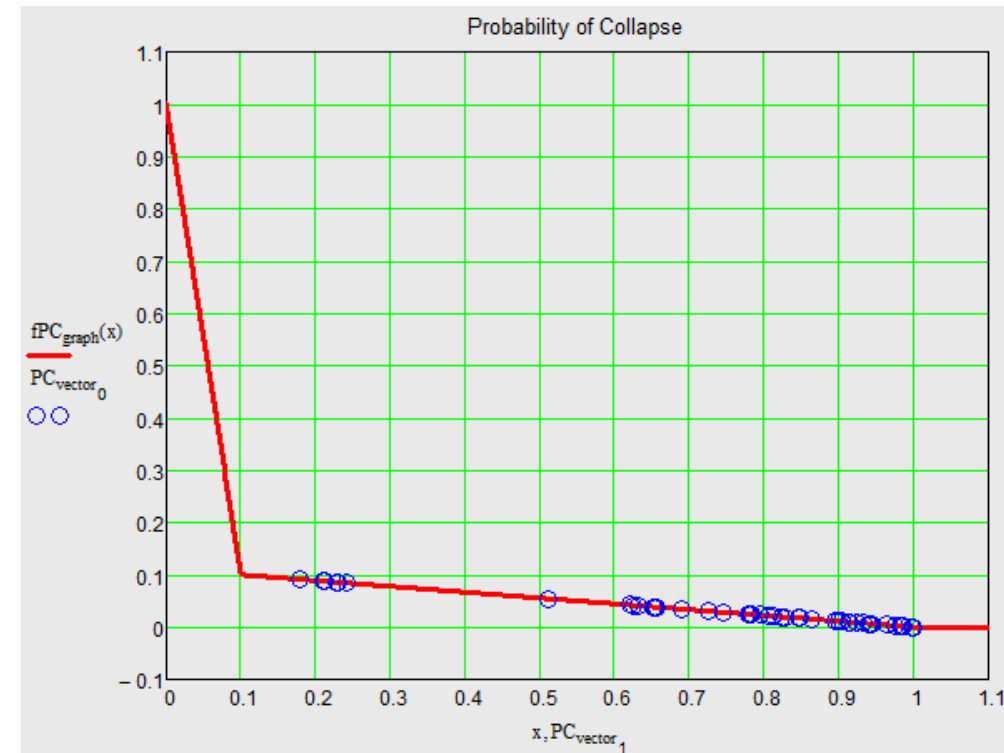

Figure 4.8.3.4-1—Probability of Collapse Distribution



Section 7: Probability of Collapse

- Vessel Collision Energy (KE) (LRFD 3.14.7):

$$KE = \frac{C_H W (V)^2}{29.2}$$

- W = Vessel Displacement (tonnes)
- V = Vessel Impact Speed (ft/s)
- C_H = Hydrodynamic Mass Coefficient = Accounts for mass of water surrounding/moving with the vessel. Increases in shallow water.

Section 7: Probability of Collapse

- Ship Collision Force on Pier (LRFD 3.14.8):

$$P_s = 8.15 V \sqrt{DWT}$$

- Vessel Collision Force on Superstructure
 - Not detailed in this presentation
 - SDG 2.11.10: *“Apply Vessel Impact Forces (superstructure) in accordance with LRFD [3.14.14.2].”*
 - LRFD 3.14.1: *“Where bridges span deep draft waterways and are not sufficiently high to preclude contact with the vessel, the minimum superstructure design impact may be taken to be the mast collision impact load specified in Article 3.14.10.3.”*

Section 7: Probability of Collapse

- Barge Collision Force on Pier (LRFD 3.14.11):

For $a_B < 0.34$,

$$P_B = 4112(a_B)$$

For $a_B \geq 0.34$,

$$P_B = [1349 + 110(a_B)]$$

Where barge bow damage length (a_B) is taken as:

$$a_B = \left[\left(1 + \frac{KE}{5672} \right)^{1/2} - 1 \right] 10.2$$

Section 8: Annual Frequency of Collapse (AFC)

$$AF = (N)(PA)(PG)(PC)(PF)$$

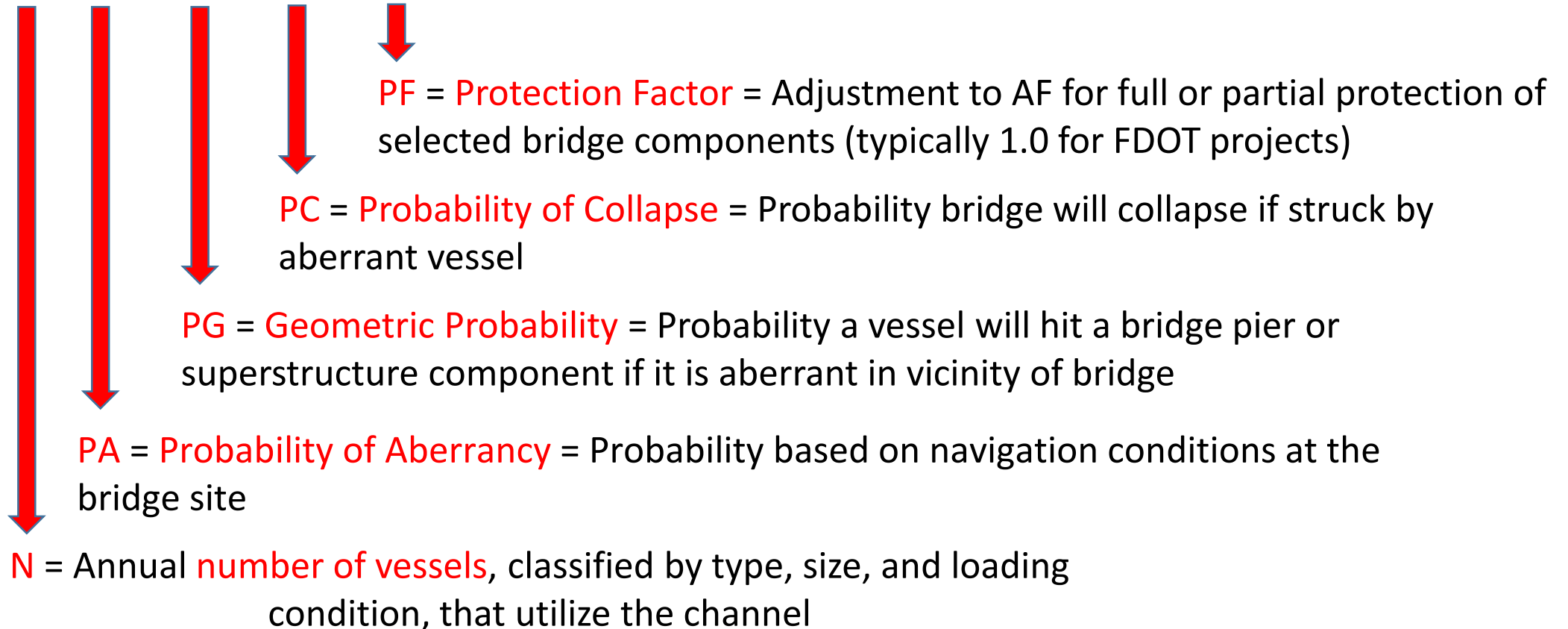

Section 8: Annual Frequency of Collapse

- The program calculates an AFC per vessel per pier and stores into a matrix.
- Next, the AFC for all vessels at each pier are summed and stored into a vector.
- Total AFC: Sum of all AFC for bridge.
 - Critical Bridge: Max allowable = 0.0001 (or Return Period = 10,000 years)
 - Regular Bridge: Max allowable = 0.001 (or Return Period = 1,000 years)

$$AFC = \text{Annual Frequency of Collapse per vessel per pier} \quad AFC_{i,j} := (N_{trips_i}) \cdot (PA_i) \cdot (PG_{i,j}) \cdot (PC_{i,j})$$

$$\text{ReturnPeriod} := \frac{1}{\text{TotalAFC}}$$

Section 8: Annual Frequency of Collapse

Water and Bridge Characteristics	Symmetrical?			
Water approach depths about longitudinal bridge axis	Yes	Yes	No	No
Water depths, pier locations, pier widths, & pier strengths about channel centerline	Yes	No	Yes	No
ANALYSIS TYPE REQUIRED	1	2	3	4

Analysis Type	Number of Runs	'SymmetricalBridge'	'Vessel Direction'
1	1	'Yes'	'Both'
2	2 ★	'No'	'Both'
3	2 ★	'Yes'	'Up' / 'Down'
4	4 ★	'No'	'Up' / 'Down'

★ Sum the individual AFC for reach analysis run to determine the Total AFC

Section 9: Pier Resistance Giving Equal AFC per Pier

- Distribute total risk as uniformly as possible, considering practical construction considerations (SDG 2.11.4.G)
- Pier strength for first 2 piers on each side of channel proportioned such that AFC per pier is less than Acceptable Risk divided by total number of piers within 6 times LOA of longest vessel group (SDG 2.11.4.H)
- Risk Analysis Program now evaluates pier resistances giving equal AFC per pier
 - Tool to help satisfy Return Period requirements, as well as address SDG criteria listed above

Section 10: Summary – LRFD Method II

- Return Period and Analysis Scope summarized
- Pier Resistance Comparison: User-defined vs. program (considering equal AFC distribution per pier)

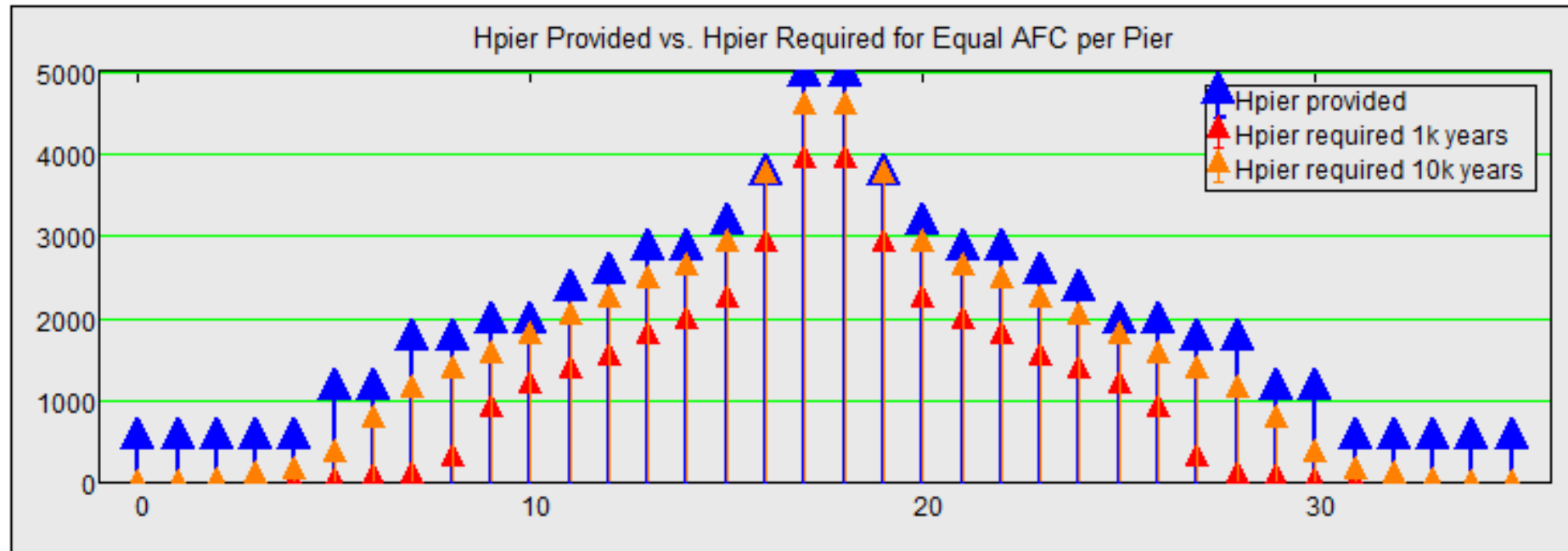

Remember: Pier resistances should be grouped for uniformity in pier design and allow for practical construction considerations.

Section 11: Importance Classification

- Operational Importance Classification: “Critical / Essential” or “Typical”?
- List of Critical bridges provided in the Risk Analysis Program
 - Consult SDO for importance classification of bridges not listed in program
- Critical classification considerations:
 - Heavy commercial marine traffic?
 - National Highway System / limited access facility?
 - Singular connection between divided cities / hurricane evacuation route?
 - Unreasonable detour to hospitals, police, and fire stations?
 - Cross over major waterways?
 - Construction cost in excess of \$40 million?
 - Etc.
- *Owner Responsibility: For Design-Build Projects, Operational Importance Classification should be clarified in the RFP.*

Section 12: Minimum Barge Collision Force

12. Minimum Barge Collision Force on Pier (PB): (LFRD 3.14.1, GS 3.12)

Default values for a standard empty 35x195 foot hopper barge

$D_{\text{water.min}}$ = Design water depth	$D_{\text{water.min}} := 10\text{-ft}$	+
$D_{\text{L.min}}$ = The empty barge draft	$D_{\text{L.min}} := 2\text{-ft}$	
W_{min} = Empty barge displacement	$W_{\text{min}} := 200\text{-ton}$	200-ton = 181.4-tonne
$B_{\text{v.min}}$ = Barge bow width	$B_{\text{v.min}} := 35\text{-ft}$	

LRFD 3.14.1:

The minimum design impact load for substructure design shall be determined using an empty hopper barge drifting at a velocity equal to the yearly mean current for the waterway location. The design barge shall be a single 35.0-ft \times 195-ft barge, with an empty displacement of 200 tons, unless approved otherwise by the Owner.

Application of Impact Force

- Use Equivalent Static Forces (LRFD 3.14.14)
 - P_T : 100% of the impact force applied parallel to channel alignment
 - P_L : 50% of impact force applied normal to channel alignment
 - Forces are not applied concurrently
 - Consider Overall Stability and Local Design

Figure 2.11.9-1 Application of Vessel Impact Forces on Footings, Piers and Columns

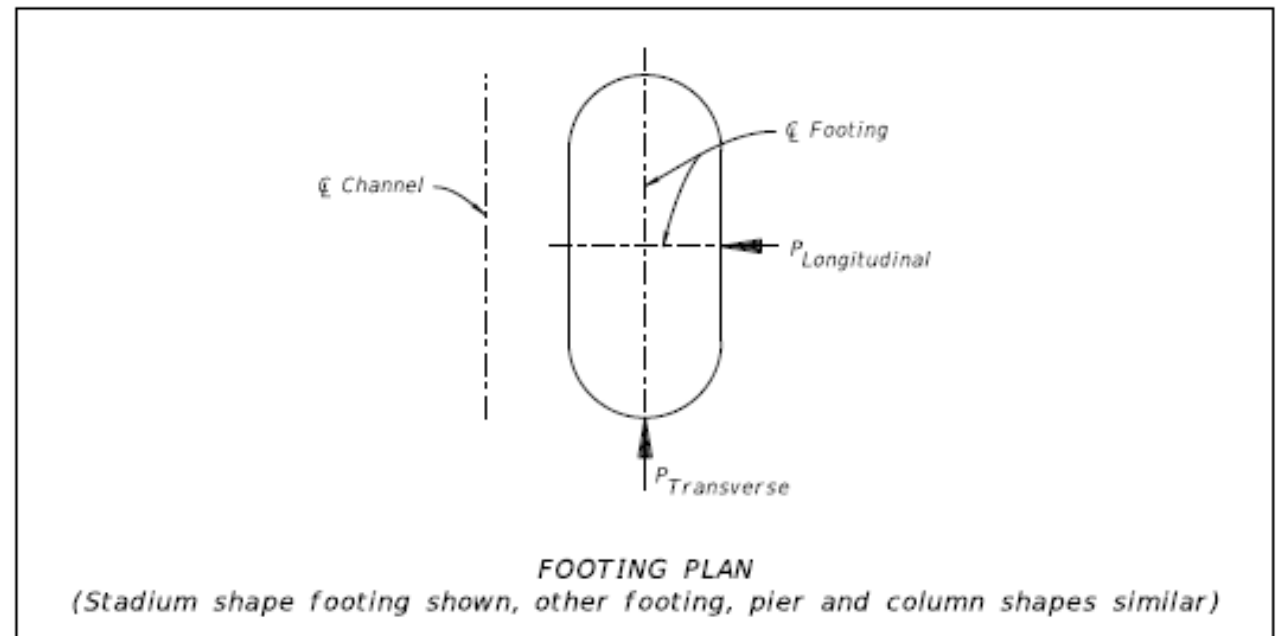

Application of Impact Force

- Overall Stability
 - Force applied as point load at MHW

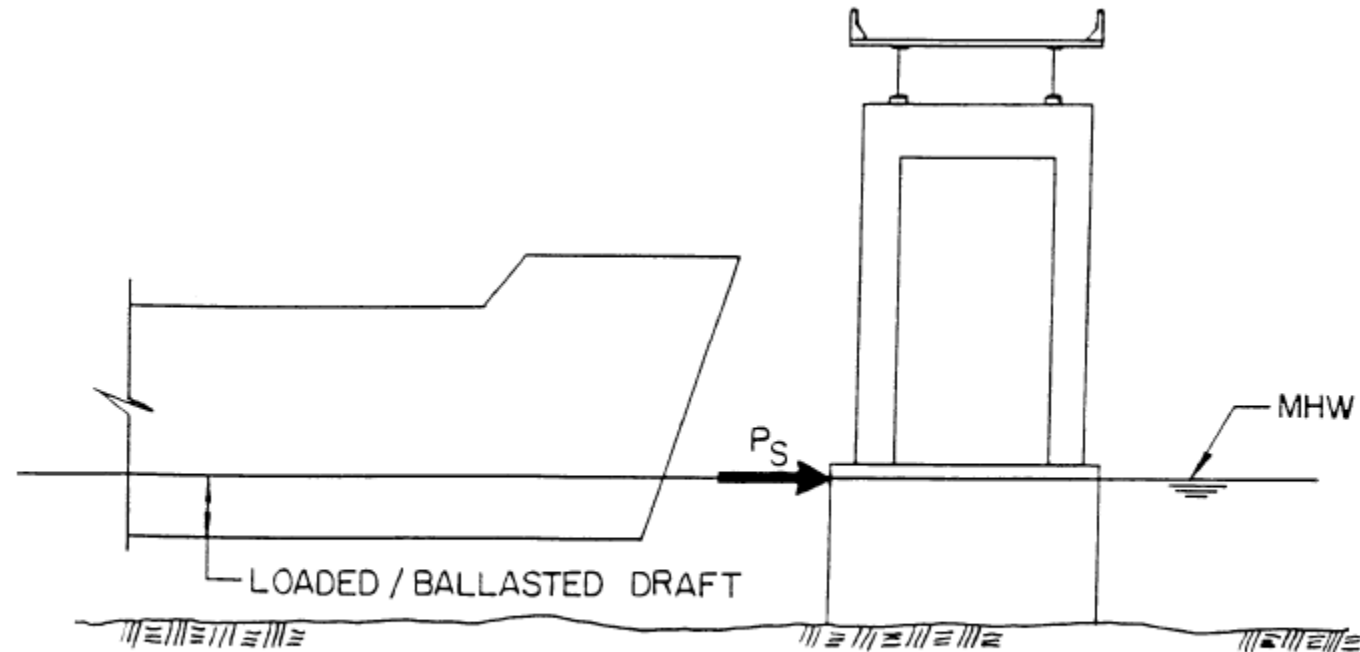

Figure 3.14.14.1-1—Ship Impact Concentrated Force on Pier

Application of Impact Force

- Local Collision Design

- Force applied as vertical line load along depth of ship bow or barge head block
- Consider bow raked forward
- Typical bow and head block depths provided in Guide Specifications

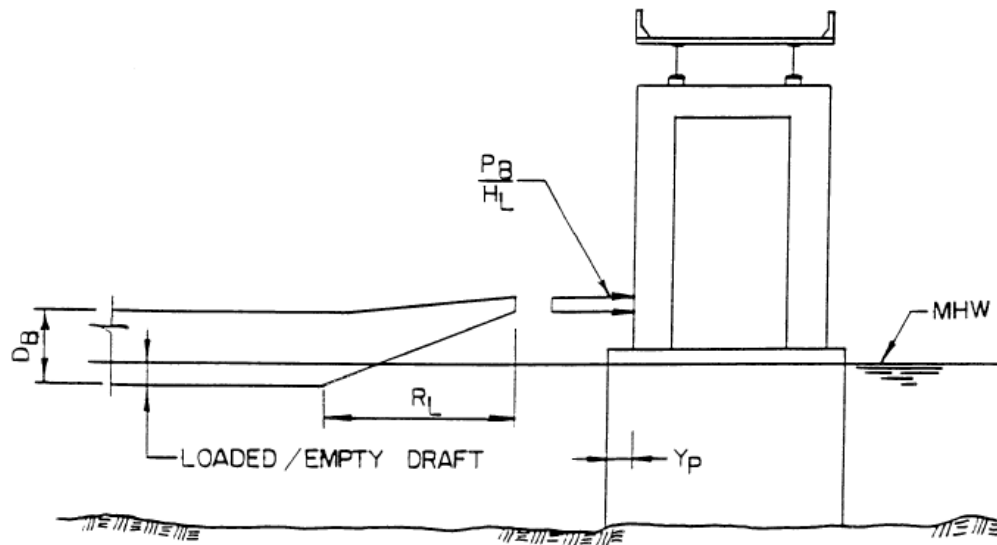

Figure 3.14.14.1-3—Barge Impact Force on Pier

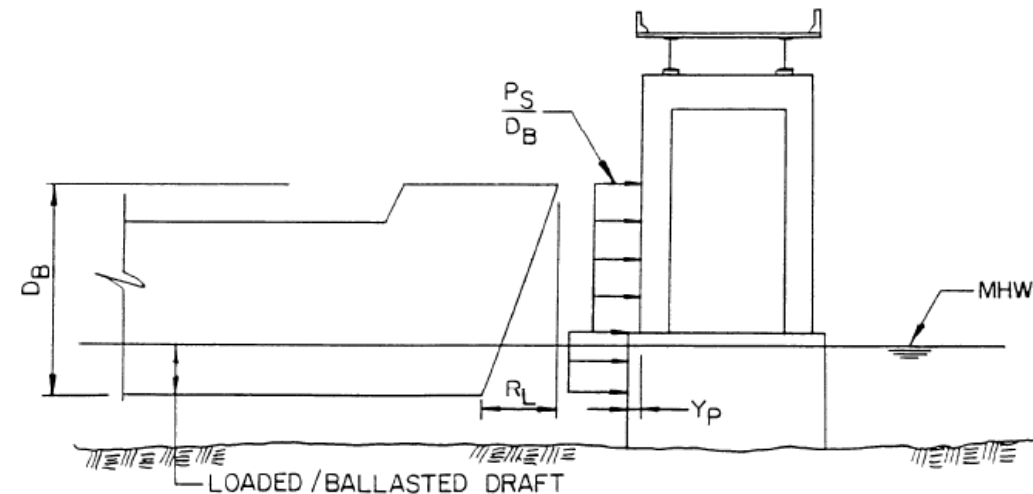

Figure 3.14.14.1-2—Ship Impact Line Load on Pier

Questions?



RS&H